

## Voltage Stability Prediction of Nigerian 330kv Network Using Arithmetic Moving Average Technique

C. O. Ahiakwo, S. L. Braide, H. N. Amadi and E. A. Ehimhen

Department of Electrical Engineering, Rivers State University, Port Harcourt Nigeria.

Corresponding Author: E. A. Ehimhen

### Abstract

The Nigeria 330kV integrated power system currently consists of the existing network, national independent power projects (NIPP), and independent power producer (IPP). This network consists of generating stations, transmission lines and buses. Consequently, the Nigeria power system is gradually transforming into complex interconnected network of different components. This complexity is because of the deregulation of the electricity industry and expansion of the network by National Independent Power Project (NIPP) and Independent Power Producers (IPP) to meet the increasing energy demand. That is due to varying load demand patterns and inability to meet both active and reactive power demand during operations coupled with number of abnormal disturbances that can result into system violation of bus-voltage, frequency-limit, and poor-power quality. Since balance between active and reactive power will ensure reliable electric power system to the consumer at receiving end. For low power factor of the system essentially indicates inefficient delivery of active power to the load due to reactive power losses. However, voltage collapse incidence may be the resultant effect of voltage instability in the power system network (PSN). This research considered the application of predictive optimizers with consideration of previous work in order to assess various voltage stability indices (VSI), particularly fast voltage stability index (FVSI), line stability index (LMN), line stability factor (LQP), voltage stability index (LD) and novel line stability index (NLSI), are presented to predict the proximity of the line close to voltage collapse. The line voltage stability indices are based on active and reactive power injections into network configuration for system analysis. Five (5) predictive indices were examined and evaluated for the predictions of voltage collapse profile for 330kv transmission network under investigation. Essentially three (3) and five (5) yearly moving average technique were also applied to analyse twenty-one (21) historical data set from (2000-2021) as actual voltage collapse information, the arithmetic moving average technique was used to determine number of voltage collapse from (2021-2032) using 5-years moving average technique with predictive look-ahead on numbers of voltage collapse as; 2021(12), 2022 (12), 2023 (12) 2024 (11), 2025 (11), 2026 (11), 2027 (11), 2028 (11), 2029 (10), 2030 (10), 2031 (10) and 2032 (10) respectively. Similarly, 3-yearly moving average also provided as; 2021(11.1), 2022 (11.4), 2023 (11.2), 2024 (11) 2025 (10.8), 2026 (10.6), 2027(10.4), 2028 (10.2), 2029(10), 2030 (10), 2031 (10), 2032 (10) respectively. The results show that the highest number of expected voltage collapse was 12 in the case of three (3) – yearly moving average which evidently fall within the year 2021, 2022, and 2023 respectively, followed by subsequent year 2024, 2025, 2026, 2027, 2028 with 11 expected number of voltage collapse and gradually becomes lowest in the year 2029-2032 with total expected number of voltage collapses to be 10. While five (5) yearly moving average techniques captured 11 numbers of voltage collapse for the year 2021-2024, and 10 numbers of voltage collapse for the year 2025-2029. The research study also introduced the application of artificial neural network (ANN), in order to measure system parameters performance, correlation, validation with input data (FVSI, LMN, LQP, LD, NLSI). The obtained quantitative value of  $R = 0.9993$ , while the validity value was 0.9993 which agrees with the data of the predictive parameters relationship. Essentially, the activity of voltage collapse can be predicted using odd-moving average in order to enable system planners/operators to put their network components structure to adapt for maximum power transfer capability.

Keywords: Loadability, Arithmetic Moving Average, Voltage Collapse, Predictive Indices, System Violation, 330kv network.

Date of Submission: 04-07-2024

Date of acceptance: 15-07-2024

**I. Background of the study**

The contemporary Power System Network (PSN) represents a vast and intricate engineering infrastructure, the vitality of which is paramount for the sustainable progress of industrial and socio-economic facets within any nation. In many developing economies, such as Nigeria, the continuous expansion and interconnection of bulk power systems have catalyzed economic growth, albeit resulting in a sophisticated network that operates within acceptable stability margins (Bhawana & Prabodh, 2015). The significance of stability studies for system limits cannot be overstated, given that the capability to forecast and alleviate the ramifications of power system breakdowns stemming from instability hinges upon the stability of system dynamics.

One type of system instability that results from heavily loaded system is voltage collapse. Voltage collapse is manifested in the form of slow variation in the system operating point because of continuous increase in load which eventually leads to corresponding decrease in magnitude of the voltage. This continuous decrease eventually results in sharp acceleration of the process until it is zero voltage in the system (Simpson-Porco et al., 2016).

Voltage collapse is a situation that leads to low drops in voltage and eventually power system blackout, these phenomena has been identified as primary power system fault that must be avoided at all costs. This is due to the magnitude of its negative impact on power system infrastructures and in turn it is highly detrimental in terms of economic impact to the society (Yahia et al., 2015).

Some causes of voltage collapse are spread out across many nations which are attributed to failure of high voltage protection equipment due to lightning strikes, generator overloading, forest fires burning down generator etc. in certain instances, the collapsing (blackout) region may span large area resulting in catastrophic damages. Thus, measurement have to be in place to forestall the occurrence of voltage collapse in power system network, one of many measures is predicted on the computation on the ground of voltage stability (collapse) indices.

In this regard, the voltage collapse or stability indices (VCSI) has been a widely researched topic that has led to the development of methods/frameworks for the identification/estimation of voltage collapse points, voltage collapse, state predictions and methods for screening out contingencies within a given power system network.

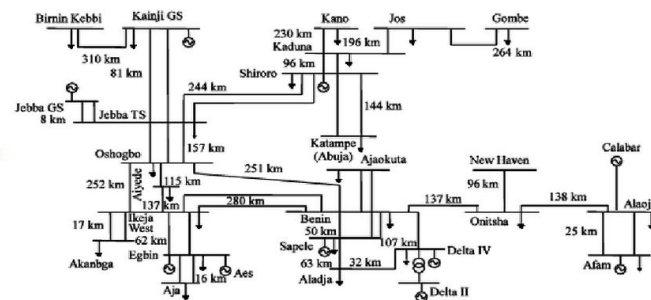

**Figure 1.1a: 28 – Bus, 330kv Nigeria Network**

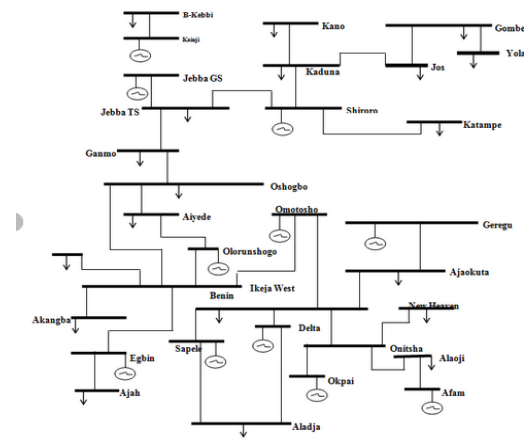

**Figure 1: Single line Diagram of 28-Bus, 330kV Nigeria Network.**

Particularly in Nigeria the need for more power-delivery devices in combination with exponential urban growth has resulted in alow voltage, leading to unwarranted blackouts experience by the citizenry.

Power system experts have described the prevailing outages as Voltage Collapse this phenomenon has been widely studied by many power system researchers around the world. Voltages collapse can hamper power system operations by denying the consumers constant and reliable source of electricity. Voltages collapse studies relate to the more general field of power systems stability for which the critical stability limits are important which major role for failure mitigation (Donna, 2018). While research is indeed very active in this field, there has been a renewed interest by power system researchers and system operators to improve existing methods or frameworks with respect to developing optimal voltage collapse index plans and preventative solutions. Thus, optimal or near optimal solution may be developed using conventional or unconventional technique.

Various research scholars study seeks to investigate the potential of different technique (eigen value) which are used essentially as a formidable analytical tool to investigate both proximity and mechanism of voltage instability. The process of voltage collapses of a dynamic occurrence but static power network solution methods which can still be utilized to generate criteria condition which are good markers of voltage stability margin and can ascertain weak buses of the system (Verayiah, 2016). Modal analysis method can calculate voltage collapse or instability in power system networks. The major aspect of this technique involves the estimation of the smallest eigen values and related eigen vectors of the reduced Jacobian matrix acquired from performing load flow analysis.

Eigenvalues have a great deal of the relationship with mode of voltage and reactive power variation and are employed to estimate voltage instability in a power network system. After execution of modal analysis, the participation factors are usually utilized to easily identify the weakest connections or buses in the system (Goh *et al.*, 2014). The participation factor values can adequately be used to determine the weakest bus in the system. The participation factor values are usually obtained from the eigen-vectors analysis or eigenvalues.

A typical modern Power System Network (PSN) is a large and complex Engineering system whose healthy existence is crucial for sustainable industrial and socio-economic development of any nation. In most developing economy like Nigeria, the continuous interconnection of bulk power system brought about by the growth in the economy which has resulted in a complex system that operates within or ever so close to the margin of stability. The importance of the study of the stability limit of the PSN cannot be overemphasized considering that the ability to predict and mitigate the consequences of power system breakdown due to instability depends on stability studies (Chayapathi *et al.*, 2017).

One type of system instability that results from a heavily loaded system is "Voltage Collapse". Voltage collapse is manifested in the form of slow variation in the system operating point because of continuous increase in load which eventually leads to a corresponding decrease in the magnitude of the voltage. This continuous decrease eventually results in a sharp acceleration of the decrease process until there is zero voltage in the system. Voltage collapse is a situation that leads to abysmally low drops in voltage and eventual power system blackout, this phenomenon has been identified as a primary power system fault that must be avoided at all costs. This is due to the magnitude of its negative impact on power system infrastructure and in turn, its highly detrimental to economic impact in the society (Onohaebi, 2019).

Thus, measures have to be put in place to forestall the occurrence of voltage collapse in a power system network. One of such measures is predicted on the computation on the ground of voltage stability (collapse) indices.

In this regard, the voltage collapse or stability indices (VCSI) has been widely researched area that has led to the development of methods/frameworks for the identification/estimation of voltage collapse points, voltage collapse state predictions and methods for screening out contingencies within a given power system network (Sarat *et al.*, 2019).

In Nigeria, the evolution of more power-hungry devices in combination with exponential urban growth has resulted in abysmally low voltages leading in turn to unwarranted blackouts experienced by the citizenry.

Power system experts have described the prevailing outages as Voltage Collapse", a phenomenon that has been widely studied by many power system researchers around the world.

Voltage collapse can hamper power system operations by denying the consumers constant and reliable source of electricity. Voltage collapse studies relate to the more general field of power systems stability for which the critical stability limits are important and play a main role failure mitigation. While research is indeed very active in this field, there has been a renewed interest by power system researchers and system operators to improve existing methods or frameworks with respect to developing optimal voltage collapse index plans and preventative solutions. Thus, optimal or near optimal solutions may be developed using conventional or unconventional but effective methods.

Optimal voltage collapse detection strategies may include a prediction layer to estimate in advance which par5 voltage collapse since it is highly catastrophic anytime it occurs.

### Review of Previous Work

Quite a number of research works abound in the field of voltage stability which defines several Voltage Stability Margins (VSMs) for use with standalized power system networks. This study on VSMs is related to the concept of voltage collapse which is typically described by a voltage stability or collapse index at a point of possible line outage or blackout; thus, a Voltage Collapse Index (VCI) typically describes the state of security of power system in the presence of a possible severe contingency.

According to Goh *et al.* (2019) voltage collapse studies are made to gain an insight into mechanisms that drive a system into collapse. To understand the dynamics of voltage collapse, the inter-play between generator controls and the connected load must be explored. Simulations must be carried out on a medium sized network by a transient dynamic simulation program.

Simulation results help to better understand remediation strategies. The time dependent characteristics of correction controls can also be investigated using the results obtained.

### What is Voltage Collapse

The term voltage collapse is often used interchangeably with system collapse. It is the process by which series of events accompanying voltage instability leads to a blackout or abnormally low voltages in a significant part of the power system. In plain terms it is a situation where the load demand outweighs the generated power which leads to pulling the generators into a state of instability, the discrepancy between power generated and power available for distribution is mainly due to either fall in water level at the hydro generating station or non-availability of gas at the thermal stations (Hasani & Parniani, 2015).

The cause of voltage collapse can be categorized into two: technical and non-technical. The technical causes may be due to tripling of lines on account of faulty equipment or increase in load than the available supply. The non-technical causes of voltage collapse include adverse weather conditions.

### Voltage Stability Studies

Voltage stability is defined as the ability of the system to maintain voltage at all nodes within the acceptable limit when subjected to a disturbance. (Musa, 2015)

A system that has the ability to develop adequate restoring forces sufficient to overcome disturbing forces and restore equilibrium is said to be stable. A system is termed insecure when the capability does not exist. Power system stability problems are commonly classified into two categories.

- (i). Steady state
- (ii). Transient

Steady state frequency controls, take care of minor disturbances (variations) in generation demand equilibrium. A system is in a steady state when all required parameters impacting on System Operations exist like adequate generation operating reserves and healthy transmission network.

Transient stability problems focus on the effect of sudden large system disturbances such as:

- (i). Line faults,
- (ii). Sudden switching off of lines,
- (iii). Sudden application or removal of large loads
- (iv). Loss of a major generating unit at a power station

The outcome of voltage instability is a progressive rise or fall of voltage at some buses. The uncontrollable of voltage magnitude at some buses on the power network is referred to as voltage instability. A typical power system operation is a combination of power generation, load demand and adequate supply of power to loads at all times. The component of a power system network that drives the system into instability is Load. (Chayapathi *et al.*, 2017).

Spinning reserve is one key tool for managing system frequency and keeping the system stable. Experience from the operation of the Nigerian Grid between 15<sup>th</sup> January 2011 and February 2012 when there was reasonably sufficient Spinning Reserve clearly showed that Spinning Reserve should be taken seriously as a tool in managing system frequency for the attainment of a more stable grid.

### Materials Used

The materials used in this research include the following:

- (i) Line input data
- (ii) Bus input data
- (iii) Conductor cross sectional area.
- (iv) Transformer input data
- (v) MATLAB/ANN
- (vi) Electrical Transient Analyzer Program (ETAP) software
- (vii) Annual Voltage Collapse data on the 330kV system network

### Method Used

Power flow studies provide systemic mathematical approach in determining the various buses voltages (V), phase angles ( $\delta$ ), active power (P) and reactive power (Q) that flows through various branches, generators and loads under steady state on a given set of loading and operating conditions. The determination of these parameters constitutes the solution to load flow problems. Load flow equations are essentially non-linear algebraic equations, which must be solved through iterative numerical techniques - by starting with assumed values of known variables and obtaining successive better values of the same variable by repeated cycles of solution. These iterative methods of solutions for load flow problems will consider the embedded Newton Raphson method / fast decoupled load flow technique (FDLF) and modal analysis techniques.

In this analysis of the Nigerian 330kV power system network, the arithmetic moving average and predictive optimization techniques are employed. The utilization of arithmetic moving average facilitates a straightforward analysis of historical data trends, thereby assisting in the identification of potential patterns or anomalies in voltage behaviour. Furthermore, the implementation of the five predictive optimizers enables a more sophisticated analysis, leveraging advanced algorithms to forecast potential voltage collapse scenarios based on current and projected operating conditions. Through the integration of these methods, the aim is to obtain critical parameters that can inform effective mitigation strategies against voltage collapse, ultimately enhancing the overall stability and reliability of the network.

The mathematical method proposed by Ramet *al.* (2018), state that under normal conditions, the electrical system is assumed to be operating at its stable pre-fault equilibrium point. The behaviour of such system is given as:

$$M \frac{d^2\delta}{dt^2} = P_m - P_e \quad (1)$$

From the analysis M is the Inertia Constant,  $P_m$  is the input mechanical Power and  $P_e$  is the Output Electrical Power. Thus, for small disturbance of the rotor angle  $\Delta\delta$  (1) becomes.

$$M \frac{d^2\Delta\delta}{dt^2} = \Delta P_m - \Delta P_e \quad (2)$$

Where the mechanical power of the generator is assumed to be constant then  $\Delta P_m = 0$  therefore (2) becomes:

$$M \frac{d^2\Delta\delta}{dt^2} = \Delta P_e \quad (3)$$

This can be rewritten as;

$$M \frac{d^2\Delta\delta}{dt^2} = \frac{1}{M} \partial P_e \Delta\delta = \frac{K_s}{M} \Delta\delta \quad (4)$$

Where  $k_s$  = Synchronizing power coefficient

Thus,

$$\frac{d^2\Delta\delta}{dt^2} = \frac{K_s}{M} \Delta\delta = 0 \quad (5)$$

Further solution to the differential equation provided two roots:

$$\lambda_1 \lambda_2 = \pm \sqrt{\frac{K_s}{M}} \quad (6)$$

the synchronizing torque given as  $K_s$

If it is positive, then the system will oscillate with imaginary roots.

$$\lambda_1 \lambda_2 = \pm jw \quad (7)$$

Where  $K_s$  is the synchronizing angular acceleration and attain stability at a different rotor angle. On the other hand, if the synchronizing torque  $K_s$  is negative, then the roots are real which characterizes the system to be unstable.

### Per-Kilometre Active Resistance (R)

$$R_o = \frac{1000\ell}{A} (\Omega/km) \quad (8)$$

$\ell$  = Where  $\ell$  is the design resistivity of the conductor (Q,m)

A = A is the cross-sectional area of conductor ( $m^2$ )

### Per-Kilometre Inductive Reactance (Non-stranded conductor)

$$x_o = 0.445 \left( \frac{D_{GMD}}{r} \right) + 0.0157 (\Omega/km) \quad (9)$$

Where  $r$  is the conductor radius

$D_{GMD}$  is the geometric mean distance between phase conductors.

**Per-Kilometre Capacitive Susceptance  $b_o$** 

$$b_o = \frac{7.58}{\text{Log}\left(\frac{D_{GMD}}{r}\right)} \times (1/\Omega/km) \quad (10)$$

**Geometric Mean Distance**

For a single Circuit

$$D_{GMD} = \sqrt[3]{D_{RB} D_{RY} D_{BY}} \quad (11)$$

Where  $D$  is the spacing between the conductors.

For overhead conductors arranged horizontally

$$\left. \begin{aligned} D_{GMD} &= \sqrt[3]{2D^3} \\ &= D \sqrt[3]{2} \\ &= 1.26D \end{aligned} \right\} \quad (12)$$

**Percentage Load analysis on Feeder**

$$\% \text{ Loading of feeder} = \frac{\text{Average Current on Feeder}}{\text{Maximum allowable current}} \times 100 \quad (13)$$

It can also be given as

$$\% \text{ Loading of Feeder} = \frac{\text{Active Power demand on Feeder}}{\text{Maximum allowable Active Load on Feeder}} \times 100 \quad (14)$$

$$\text{Where Active Power (P}_D\text{) on feeder} = \frac{\text{Average Current on Feeder}}{60} \times 100 \quad (15)$$

**Complex Load on Distribution Transformers**

Complex load demand = Transformer Capacity  $\times$  Percentage Loading on transformer

$$\text{Where percentage loading on transformer} = \frac{I_R + I_Y + I_n}{3I_n} \times 100 \quad (16)$$

**Voltage Drop ( $V_D$ )** given as:

$$V_D = V_s - V_r \quad (17)$$

Where  $V_s$  = Sending end Voltage

$V_r$  = Receiving end Voltage

$$\text{And } V = IZ \quad (18)$$

$$\text{Thus, } V_D = V_s - V_r = IZ \quad (19)$$

Where  $I$  = Average Current on Feeder       $Z$  = Impedance of feeder

$$\text{Therefore, percentage voltage drop} = \frac{V_D}{V_s} \times 100 \quad (20)$$

**Transformer Tap Changing**

The principle of regulating the secondary voltage is based on changing, the number of turns on the primary or secondary in changing the transformation ratio are presented as,

$$\frac{V_2}{V_1} = \frac{N_2}{N_1} = K \quad (21)$$

$$V_2 = \frac{V_1 N_2}{N_1} = E_1 K \quad (22)$$

Where K : transformation ratio

$V_1$  : primary voltage

$V_2$  : secondary voltage

Decrease in primary turns causes increase in emf per turn, and so in secondary output voltage. Secondary output voltage can also be increased by increasing secondary turns and keeping primary turns fixed.

**Shunt Capacitors for Compensation**

Shunt capacitors are installed near load terminals to provide leading Volt-Ampere-Reactive (VAR) and thus to reduce the line current. Hence, by using shunt capacitors, line drop is reduced, and voltage profile is improved. Shunt capacitors are switched in when capacity demand on the distribution system rises and voltage of the buses drop.

Assume a load is supplied with a real power P, lagging reactive Power,  $Q_1$  and apparent power,  $S_1$  at a lagging power factor.

Thus,

$$S_1 = (P^2 + Q_1^2)^{\frac{1}{2}} \tag{23}$$

When a Shunt Capacitor of  $Q_c$  KVar is installed at the load, the apparent power can be reduced from  $S_1$  to  $S_2$ .

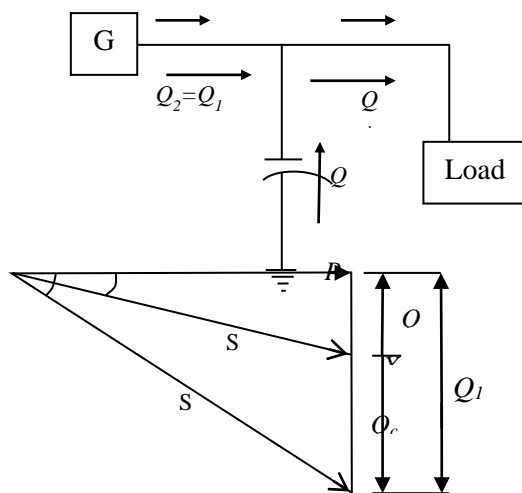

**Figure 2:** Pythagoras theorem for capacitor compensation (capacitor bank)

$$S_2 = (P^2 + Q_2^2)^{\frac{1}{2}} \tag{24}$$

Similarly,

$$S_2 = (P^2 + (Q_1 - Q_c)^2)^{\frac{1}{2}} \tag{25}$$

Since current is directly proportional to power, (i.e.  $I \propto S$ ), automatically, reduction in the apparent power leads to reduced current flow. In turn line drop is reduced and voltage profile improved.

**Power Factor Correction**

If P is the real power supplied, Q is the lagging reactive power and S is the apparent power at alagging power

factor. Then  $\cos \theta_1 = \left( \frac{P}{S_1} \right)$  (26)

and

$$\cos \theta_1 = \frac{P}{(P^2 + Q_1^2)^{\frac{1}{2}}} \tag{27}$$

When a shunt capacitor supplying reactive power of  $Q_c$  is applied, the new reactive power  $Q_2$  of the system will be

$$Q_2 = Q_1 - Q_c \tag{28}$$

Hence, power factor becomes.

$$\cos \theta_2 = \frac{P}{(P^2 + Q_2^2)^{\frac{1}{2}}} \quad (29)$$

and

$$\cos \theta_2 = \frac{P}{(P^2 + Q_1 - Q_c)^{\frac{1}{2}}} \quad (30)$$

### Objective Function of Optimal Capacitor Placement (OCP)

The objective of OCP is to minimize the cost of the system. This cost is measured in four ways:

- (i) Fixed capacitor installation cost
- (ii) Capacitor purchase cost
- (iii) Capacitor bank operating cost (maintenance and depreciation)
- (iv) Cost of real power losses.

Mathematically, cost can be represented as:

*Min objective function*

$$\sum_{i=1}^{N_{bus}} (x C_{oi} + Q_{ci} C_{1i} + B_i C_{2i} T) + C_2 \sum_{i=1}^{N_{bus}} T_1 P_L^1 \quad (31)$$

Where  $N_{bus}$ : Number of bus candidates

$x_i$ : 0/1, 0 means no capacitor installed at bus  $i$

$C_{oi}$ : Installation cost

$C_{1i}$ : Per Kvar cost of capacitor banks.

$Q_{ci}$ : Capacitor bank size in Kvar

$B_i$ : Number of capacitor banks

$C_{2i}$ : Operating cost per bank, per year

$T$ : Planning period (years)

$C_2$ : Cost of each KWh loss, in \$/KWh

$l$ : Load levels, maximum, average and minimum

$T_1$ : Time duration, in hours, of load level

$P_L^1$ : Total system loss at load level

### Arithmetic Moving Average Technique

Arithmetic moving average (also known as a simple moving average, SMA) commonly used as statistical calculation in time series analysis and forecasting). It is computed by taking the average of a series of data points within a specific period. The formula for calculation of SMA are defined, the parameter definition is stated as.

$$SMA = \frac{X_1 + X_2 + \dots + X_n}{n} \quad (32)$$

Where,

SMA: the simple moving average.

$X_1, X_2, \dots, X_n$  are the data points within the chosen period.

$n$ : the number of data points in the period

### ARIMA (Auto Regressive Integrated Moving Average):

ARIMA is a complex time series forecasting model that combines autoregressive (AR) and moving average (MA) components with differencing to make the data stationary. The ARIMA model is represented as: ARIMA (p, d, q) where:

$p$ : the order of the autoregressive components.

$d$ : the degree of differencing (the number of times differencing is applied to make the data stationary)

$q$  the order of the moving average components.

The governing equations for ARIMA involves the following steps:

- (i). Differencing: make the time series data stationary by differencing it times until it becomes stationary.



The difference series is denoted as  $Y_t$ .

- (ii). Auto-regression (AR) components: Fit an autoregressive model of order  $p$  to the differences data  $Y_t$ . This involves estimating coefficients for lagging values of  $Y_t$  and expressing  $Y_t$  as a function of its past values.

$$Y_t = \phi_1 Y_{t-1} + \phi_2 Y_{t-2} + \dots + \phi_p Y_{t-p} + \varepsilon_t \quad (33)$$

Where;

$\phi_1, \phi_2, \dots, \phi_p$  are the autoregressive coefficient, and  $\varepsilon_t$ , is the noise or error term.

### Moving Average (MA) Components

In computing moving average model of order  $q$  to account for the lagged forecast errors ( $\varepsilon_t$ ).

That is,

$$\varepsilon_t = \theta_1 \varepsilon_{t-1} + \theta_2 \varepsilon_{t-2} + \dots + \theta_p \varepsilon_{t-p} \quad (34)$$

Where;

$\theta_1, \theta_2, \dots, \theta_q$  are the moving average coefficient.

Forecasting: The ARIMA model is fitted using the forecasting future values of the time series.

ARIMA – model is widely used in time series analysis and forecasting, especially for data with trends and seasonally. The choice of  $p$ ,  $d$ , and  $q$  values depends on the specific characteristics of the data and requires model selection technique.

The governing equation for the simple –moving average (SMA) are provided, that is SMA is calculated by summing up a set of data points and divide by the number of data points in the period thereby providing a moving average value that smooths out fluctuations in the data over that period.

Moving average method, consists of measurement of trend by “smoothing out” fluctuations of data by means of moving average. Moving average technique can consider the extent (or periods) when  $m$  is a series of successive average (arithmetic means) of  $m$  terms at a timewhile starting from 1<sup>st</sup>, 2<sup>nd</sup>, 3<sup>rd</sup> term etc. The first average is the mean of the 1<sup>st</sup>,  $m$  terms, and grid is the mean of the  $m$  term from 2<sup>nd</sup> to  $(m+1)$ <sup>th</sup> terms, the third is the mean of the  $m$  terms from 3<sup>rd</sup> to  $(m+2)$ <sup>th</sup> term, and so on.

### Choice of Simple Moving Average for Forecasting

Simple Moving Average (SMA) as a method for statistical prediction is simple and easy to understand and made use of just as the name implies, providing smoothing effect, reducing noise, and highlighting trends. It is less sensitive to outliers compared to other methods as well as its flexibility that allows the choosing of the window size for the analysis (Vaidya, 2020).

### Exponential Smoothing

Exponential Smoothing though provides more weight to recent observations, capturing changes more quickly, it has the disadvantages of not performing well with data containing long-term trends and requires tuning of smoothing parameters which can be subjective.

### Auto Regressive Integrated Moving Average (ARIMA)

In the case of ARIMA which captures complex patterns and long-term trends in data, it requires stationarity of the data under investigation which may not necessitate differencing. Parameter estimation and model selection can be challenging (Hayes & Munichiello, 2021).

Based on the comparison of the different forecasting methods as stated above, Simple Moving Average (SMA) is preferred to the other methods for the prediction of the expected voltage collapse on the 330kV network. Although ARIMA offer a greater flexibility and predictive power, SMA stands out for its simplicity, robustness, and ease of interpretation. SMA provides a basic yet effective approach for smoothing out noise in the data and capturing underlying trends, making it particularly suitable for applications where a quick and straightforward forecasting method is needed. Additionally, SMA can serve as a useful baseline for comparison with more complex methods, allowing for a better understanding of the data and the performance of alternative forecasting approaches. Therefore, for forecasting the number of collapses over the next 10 years, thereby justifying its balance of simplicity, interpretability, and reliability.

### Application Approach to Simple Moving Average, SMA Technique

Many types of data smoothing method are normally applied or in use, but the commonest type is the simple moving average, SMA and is computed as;

$$\hat{y}_i = \frac{\sum_{j=i-k}^{i-k} y_j}{m} \quad (35)$$

Where;

$$K = \frac{m-1}{2}$$

i: point location of the estimated moving average value usually placed with respect to j

j: point location of the observed time series data, and

m: length of the smoothing interval or number of points over which the average is computed.

Alternatively, a simple moving average of order m is given by the sequence of arithmetic means as;

$$\frac{y_1 + y_2 + \dots + y_m}{m}, \frac{y_2 + y_3 + \dots + y_{m+1}}{m}, \frac{y_3 + y_4 + \dots + y_{m+2}}{m}, \dots \quad (36)$$

The sum in the numerators of (3.169) are called totals of order m. while (3.168 and 3.169) defines an interval centered around the point to be estimated. If m is an odd number, then the “estimated”  $\hat{y}$  must corresponds with the central point. If m is even, a set of value y will be estimated that will be mid-way between adjacent observations. However, the smoothing interval extends  $(m-1)/2$  observations on either side of the estimated point, observations near the beginning and the end of the sequence cannot be estimated if m is three (3), that is the sequence (smoothed data) by two (one at both ends of data) are noted strongly.

Essentially, when data are given annually, monthly, or hourly, a moving average of order m is considered for analysis which is called an m-year moving average or m-hours moving average.

For example, data collected due to lightening surges on transmission voltage collapse history are generated as; 8, 24, 4, 20, 12, 28, 8 requested to determine the sequence of moving average.

Applying the simple moving average technique (SMA), following the sets of data as; 8, 24, 4, 20, 12, 28, 8 for a

$$3\text{- yearly moving average } SMA1 = \frac{8+24+4}{3}, \frac{24+4+20}{3}, \frac{4+20+12}{3},$$

$$\frac{20+12+28}{3}, \frac{12+28+8}{3} \text{ giving the arithmetic value as } 12, 16, 12, 20, 16 \text{ respectively (that is taking } m =$$

3 moving average order).

$$K = \frac{m-1}{2} = 1$$

$$\hat{y}_i = \sum_{j=i-1}^{i+1} y_j / 3$$

The point location for the 1<sup>st</sup> computed moving average will take a 2<sup>nd</sup> position with respect to those of the observed data set when m = 3, i is assumed value from 2 to 6.

$$\text{For } i = 2, \hat{y}_1 = \sum_{j=1}^{i+1} y_j / 3 = (y_1 + y_2 + y_3) / 3 = 12$$

$$i = 3, \hat{y}_2 = \sum_{j=2}^4 y_j / 3 = (y_2 + y_3 + y_4) / 3 = 16$$

$$i = 4, \hat{y}_3 = \sum_{j=3}^{i+1} y_j / 3 = (y_3 + y_4 + y_5) / 3 = 12$$

$$i = 5, \hat{y}_4 = \sum_{j=4}^6 y_j / 3 = (y_4 + y_5 + y_6) / 3 = 20$$

$$i = 6, \hat{y}_5 = \sum_{j=5}^7 y_j / 3 = (y_5 + y_6 + y_7) / 3 = 16$$

#### Composite Line Graph for Voltage Collapse Prediction

The composite bar chart presented in this analysis illustrates the annual voltage collapse within the 330kV network, alongside the 3 and 5 yearly moving average trends. These visual representations serves as vital tools in assessing the stability and performance of the network, offering insights into voltage fluctuations over time.

By examining these trends, stakeholders can gain valuable insights into the network’s resilience and identify potential areas for improvement.

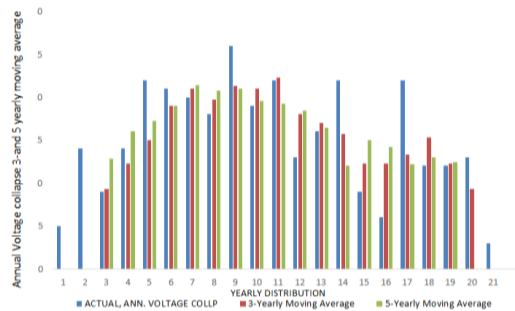

**Figure 3: Composite Bar Chart of Actual Annual Voltage Collapse, 3 and 5 yearly Moving Average Trend for 330kv Network Assessment**

Figure 3 presents a visual representation in the form of a composite bar chart. This chart serves as a valuable tool for conducting an annual analysis of voltage collapse occurrences. Within this analysis, two distinct moving average techniques are employed: a three-year moving average and a five-year moving average. The primary objective is to assess the performance of the 330kV networks for accurately predicting the annual number of voltage collapses.

The dataset utilized in this analysis comprises twenty-one historical records, meticulously documenting actual instances of voltage collapses. These records span a comprehensive period from 2000 to 2021, provided a substantial overview of voltage stability within the studied network. The recorded number of voltage collapses for each year, arranged chronologically, is as follows: 5, 14, 9, 14, 22, 21, 20, 18, 26, 19, 22, 13, 16, 22, 9, 6, 22, 9, 6, 22, 12, 12, 13, and 3.

Through a thorough examination of this dataset and the application of arithmetic moving average techniques, our objective is to delve deeper into the underlying trends and variability of voltage collapse occurrences across the analyzed time frame. This analytical endeavour serves as an indispensable tool in evaluating the reliability and performance of the 330kV networks concerning voltage stability and system resilience, offering valuable insights into the dynamics of power system operation and management.

**Table1: Analysis Data for Actual/Annual Voltage Collapse for 3 and 5 Yearly Moving Average Assessment for Data Plots**

Year	3-Yearly Moving Average	5-Yearly Moving Average
2000	0	0
2001	0	0
2002	9.3	12.8
2003	12.3	16
2004	15	17.2
2005	19	19
2006	21	21.4
2007	19.7	20.8
2008	21.3	21
2009	21	19.6
2010	22.3	19.2
2011	18	18.4
2012	17	16.4
2013	15.7	12
2014	12.3	15
2015	12.3	14.2
2016	13.3	12.2
2017	15.3	13
2018	12.3	12.4
2019	9.3	0

Voltage collapse is a critical phenomenon in power system operation, representing a significant risk to grid stability and reliability. In this analysis, we delve into the assessment of actual annual voltage collapse occurrences, alongside the examination of 3 and 5 yearly moving average trends, specifically within the context of a 330kV network.

Understanding the dynamics of voltage collapse is paramount for ensuring the robustness and resilience of electrical grids, especially in high-voltage networks where the stakes are particularly high. By analyzing historical data on actual voltage collapse events and observing longer-term trends through moving averages, we aim to provide insights into the stability performance of the 330kV network. This analysis will not only serve to quantify the frequency and severity of voltage collapse incidents but also seeks to identify underlying patterns and trends that may indicate vulnerabilities or areas for improvement within the network infrastructure. By examining both short-term variations and longer-term trends, we gain a comprehensive understanding of voltage stability dynamics, enabling us to make informed decisions to enhance grid resilience and reliability. Through this assessment, we aim to provide stakeholders with valuable insights and recommendations for optimizing voltage stability within the 330kV network, ultimately contributing to the continuous improvement of grid performance and the mitigation of potential risks associated with voltage collapse.

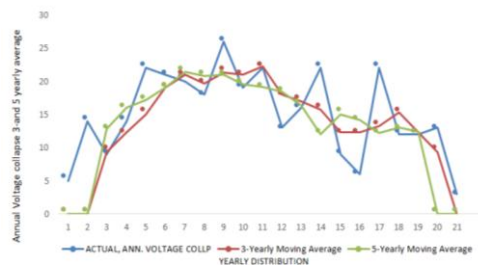

**Figure 4: Composite Line Graph of Actual Annual Voltage Collapse, 3 and 5 Yearly Moving Average Trend for 330kv Network Assessment**

In Figure 4 a composite line graph is depicted, offering a comprehensive illustration of annual voltage collapse occurrences. The graph also showcases the trends discerned through the application of both three-year and five-year moving averages. This analytical approach is instrumental in evaluating the performance of the 330kV network over time. By scrutinizing data from 2000 to 2021, this analysis aims to track the expected number of voltage collapses, enabling a thorough examination of historical trends. Moreover, it serves as a pivotal resource for informing future planning considerations related to voltage stability within the network, ensuring proactive measures are taken to enhance system resilience and reliability.

"Figure 5 presents a graphical representation of a composite bar chart utilized in the annual voltage collapse analysis of 330kV networks.

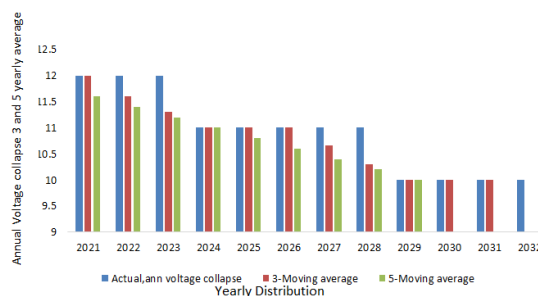

**Figure 5: Composite Bar Chart of Actual Annual Voltage Collapse, 3 and 5 yearly Moving Average Trend for Collapse Prediction on the 330kv Network.**

The technique employs both three-year and five-year arithmetic moving averages to assess the prediction of voltage collapses over the course of each year. By examining the number of voltage collapses annually, this analysis offers valuable insights into the stability and reliability of the network infrastructure. Through the visual representation provided in Figure 5, trends and patterns in voltage collapses can be

effectively observed, aiding in the development of proactive measures to enhance network performance and mitigate potential disruptions."

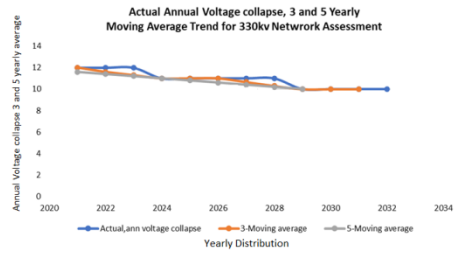

**Figure 6: Composite line Graph for Actual Annual Voltage Collapse, 3 and 5 yearly Moving Average Trend for 330kv Network Assessment**

Figure 6 shows graphical representation of composite chart for annual voltage collapse analysis using three (3) and five (5) yearly arithmetic moving average for the assessment of 330kv networks prediction for number of voltages collapses annually. Twenty-one (21) historically data set were obtained as actual voltage collapse record which are: (5, 14, 9, 14, 22, 21, 20, 18, 26, 19, 22, 13, 16, 22, 9, 6, 22, 9, 6, 22, 12, 12, 13 and 3) from the year (2000-2021). The arithmetic moving average technique was used to determine number of voltage collapse while historical prediction of voltage collapse for previous occurrence are determined for future projection to secure system planning, system security for reliable power supply. Prediction of the expected number of voltage collapse using three (3) and five (5) yearly moving average are used to predicts the voltage collapse given as; (12, 12, 12, 11, 11, 11, 11, 11, 10, 10, 10, and 10) for three (3) and (11.1, 11.4, 11.2, 11, 10.8, 10.6, 10.4, 10.2 and 10) for five (5) respectively from (2021-2032) projection. The results evidently shows that the highest number of expected numbers of voltage collapse was 12 using three (3) yearly moving average which evidently fall within the year 2021, 2022 and 2023 respectively. Then followed by subsequent year 2024, 2025, 2026, 2027, 2028 with 11 expected number of voltage collapses, and gradually becomes lowest in the year 2029-2032 with total expectation number of voltage collapse to be 10 while five years moving average techniques captured 11 number of voltage collapse for the year 2021-2024, 10 number of voltage collapse for the year 2025-2029.

**Table 2: Projection for Actual/Annual Voltage Collapse using 3 and 5 Yearly Moving Average Assessment for Data 2021 - 2032**

Year	Actual, Ann voltage collapse	3-Moving average	5-Moving average
2021	12	12	11.6
2022	12	11.6	11.4
2023	12	11.3	11.2
2024	11	11	11
2025	11	11	10.8
2026	11	11	10.6
2027	11	10.66	10.4
2028	11	10.3	10.2
2029	10	10	10
2030	10	10	
2031	10	10	
2032	10		

## II. Conclusion

The Nigerian power network comprises of limited number of generating stations, predominantly situated in remote areas near raw fuel sources. These stations are often linked to the load centers by extensive transmission lines. Generation, transmission, distribution, and marketing of electricity in Nigeria are statutory functions handled by the electricity utilities, notably the Power Holding Company of Nigeria, among others.

Currently, the installed generating capacity stands at approximately 12,522MW, with a maximum dispatch capacity of about 4000MW, serving a population exceeding more than 200 million people, this represents gross inadequacy in meeting the demand for electric power supply to the consumers at receiving end. Therefore, there is, an urgent needs to augment current projected capacity of electricity supply to alleviate system overloads and prevent network collapses from occurring regularly.

Voltage stability is imperative for optimal system performance. Variations in load demand can also trigger system overloads or disturbances that may lead to total outages or blackouts. Therefore, reliable power supply is crucial to enhance daily utility from the system buses.

In this regard, historical data on voltage collapse incidents have been gathered to assess network behavior. The study adopted the three-year and five-year moving average techniques to analyze the annual number of voltage collapses between 2000-2021 to 2021-2032. The predictive models actually shows the highest number of expected voltage collapses to be 12, occurring in the years 2021, 2022, and 2023, followed by 11 collapses expected between 2024-2028, and 10 collapses predicted between 2029-2032.

## III. Recommendation

From the results obtained in this study under investigation, the following research recommendation are considered in order to further improve sustainability and reliability operation of the Nigeria network as:

- (i) Integration of grid decentralization strategy into geopolitical zones to alleviate system overload.
- (ii) Incorporation of artificial neural network Algorithm Architecture (ANN) into grid network to measure and evaluate system parameters correlation, performance, validation to avoid system mismatches.
- (iii) Advanced predictive optimizer indices (NLSI, LMN, FVSI) software to be included in order to assess system loadability limits for maximum power transfer capability.
- (iv) Penetration of high-profile power electronic controller static var placement to enhance production of active power needed for active power delivery to the load.
- (v) The formulated mathematical framework of active and reactive power injection should be included as a "Test-bench" to evaluate and assess maximum loadability limit exhaustion to avoid system collapse.
- (vi) Consideration of power controller for system improvement particularly for:
  - Installing Flexible Alternating Currents Devices (FACTS)
  - Integration of Distributed Generation (DG)
  - Provision of transformer tap changing techniques.

## REFERENCES

- [1]. Bhawana, T. & Prabodh, K. (2015). Voltage Stability Evaluation Using Modal Analysis. *International Journal of Scientific Research Engineering & Technology (IJSRET)*, 4(4), 408-411.
- [2]. Chayapathi, V., Sharath, B., & Anitha, G. S. (2017). Voltage collapse mitigation by reactive power compensation at the load side. *IJRET: International Journal of Research in Engineering and Technology*, 2(9), 251 -257
- [3]. Donna, R. (2018). Algebra lesson page. Retrieved February 12, 2016, from Error in Measurement: [Http://www.regentsprep.org/regents/math/algebra/ani3/LError.htm](http://www.regentsprep.org/regents/math/algebra/ani3/LError.htm)
- [4]. Goh, H. H., Chua, Q. S., Lee, S. W., Kok, B. C., Goh, K. C., K., T. K. (2014). Line voltage stability indices based on precautionary measure approximation in smart grid. *Proceedings of the 11<sup>th</sup> International Conference on Innovation & Management (1507-1518)*. Finland: the University of Vaasa.
- [5]. Goh, H. H., Chua, Q. S., Lee, S. W., Kok, B. C., Goh, K. C., K., T. K., et al. (2019). Comparative study of line voltage stability indices for voltage collapse forecasting in power transmission system. *Rio de Janeiro Brazil*, 13(2), 270-275.
- [6]. Hasani, M., & Parniani, M. (2015). Method of combined static and dynamic analysis of voltage collapse in voltage stability assessment. *2005 IEEE/PES Transmission and Distribution Conference & Exhibition: Asia and Pacific (1-6)*. Dalian, China: IEEE.
- [7]. Hayes, A., & Munichiello, K. (2021). Autoregressive integrated moving average (arima). *Investopedia*. Retrieve on, 31.
- [8]. Musa, H. (2015). An overview on voltage stability indices as indicators of voltage stability for networks with distributed generations penetration. *International Journal of Science, Technology and Society.*, 3(4), 214-219.
- [9]. Onohaebi, O. (2019). Power outage in the Nigeria transmission grid. *Research Journal of Applied Sciences*, 4(1), 1-9.
- [10]. Ram, S. S., Daram, S. B. Venkataramu P. S. & Nagaraj, M. S. (2018). "Analysis of ZIP load modalling in power transmission system," *International Journal of Control and Automation*, 11(7), 11-24.
- [11]. Sarat, K. S., Suresh S. R. & Jayaram Kumar S. V. (2019). New voltage stability index (NVSI) for voltage stability analysis in power system. *International Journal of Electrical and Electronics Engineering Research (IJEERj)*, 2(4), 13-20.
- [12]. Simpson-Porco, J. W., Dörfler, F., & Bullo, F. (2016). Voltage collapse in complex power grids. *Nature communications*, 7(1), 10790.
- [13]. Verayiah, R., M. A. (2016). Performance comparison of voltage stability indices for weak bus identification in power systems. *4th International Conference on Energy and Environment 2013 (ICEE 2013)* ( 1-5). IOP Publishing.
- [14]. Yahia, E. Z. Elsherif, M. A. & Zaggout, M. N. (2015). Detection of proximity to voltage collapse by using L- Index. *International Journal of Innovative Research in Science, Engineering and Technology*, 4 (3), 1755-1765.