

THE GLOBAL POLITICS?...(*A New theory on “Universal Dam”*)

M.Arulmani, V.R.Hema Latha,

B.E. (Engineer, M.A., M.Sc., M.Phil.(Biologist)

Abstract: - This scientific research article focus that the “FISSION”, “FUSION” in Astronomical terms shall be considered as the “GLOBAL POLITICS” of super nature by **decay, Annihilation** of atoms for formation of various matters for betterment of human and sustainability of life system on the “EARTH PLANET”.

“RAIN” shall be considered as the one of the fundamental matters of universe essential for all life. This research focus that “Earth” shall be considered as the “UNIVERSAL DAM” acts as a storage device of “Rain” in the form of “OCEAN” for existence of all matters of universe under “ELECTROMAGNETIC EQUILIBRIUM”. In proto Indo Europe Language the “Earth Planet” shall be called as “MA-DAM”. Ma-Dam shall mean Universal dam of “Natural Rain Water Harvest”.

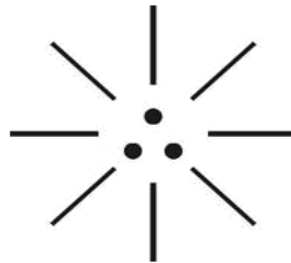
**(MA-DAM)**

“Rain shall be considered as the natural product of “Fission”, “Fusion” action for the betterment of mankind and sustainability of life”.

- Author

Keywords: -a) *Philosophy of “White Blood”*b) *Philosophy of “Earth dam”*c) *Philosophy of “J-politics”***I. INTRODUCTION**

It is focused that rain shall be considered as the natural product given by super nature for the benefit of mankind. The “Ancient Dam” shall be considered as the judicial way of storing the rainwater for best intermittent use of it before reaching the Ocean. But today “**global level human politics**” going on sharing of **ocean, border, dam water**, due to high level intelligent act of “**intellectual politicians**”. This research attempts to focus the philosophy of “POLITICS” within the following cope.

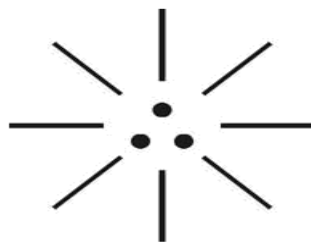
**(POLITICS LOGO)**

- i) "Politics" shall mean "Godly rule"
- ii) "Politics" are like "Fission and Fusion"
- iii) "Politics" is for promoting "Peace of life"

II. HYPOTHESIS AND NARRATION

a) Philosophy of Rain?...

It is hypothesized that the philosophy of "Rain" shall be considered as the "Natural Product" due to impact of "J-Radiation" of super nature by action of "Fission" and "Fusion" of fundamental particles of "J-Radiation". The consistent impact of J-Radiation shall also be called as "J-politics" or "Godly politics".

(i)

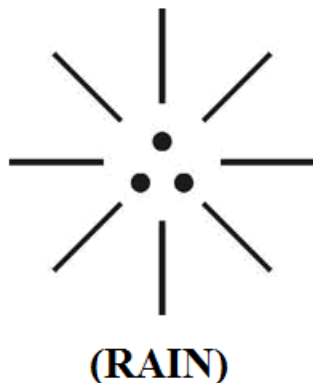

(ii)

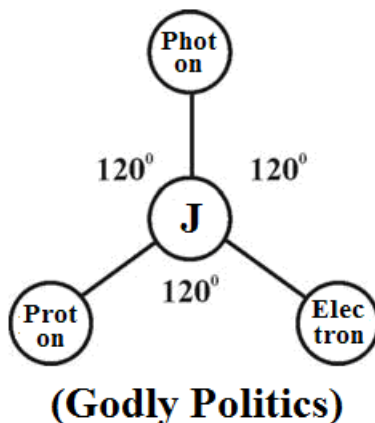

b) Rain is organic or inorganic?...

It is hypothesized that rain shall be considered as **purely inorganic** contains only fundamental ions of PHOTON, ELECTRON, PROTON and free from **atoms** hydrogen, carbon, nitrogen, ozone. Whereas the oceans considered contains atoms, molecules subsequently acquired during natural process of osmosis and reverse osmosis due to impact of variation in salinity level of ocean in different regions. In fact the rain water shall be considered as having PH value of zero and the ocean water considered contains billions of **species** PH ranging from above zero level to 14.

c) Philosophy of ocean?...

It is hypothesized that the philosophy of ocean shall be considered as the "Transformed state" of natural rain and collected in the "EARTH DAM" in three geological ages for existence of all matters under "electromagnetic equilibrium" condition such as coal, coke, lignite, minerals, various types of rocks, soils, formation of natural sands, etc. It is hypothesized that the earth dam considered constructed strongly and continue to be strong enough for another **1000 years** definitely. The "ocean" shall be considered as "Image" of "Rain". The Philosophy of rain and ocean shall be described as below.

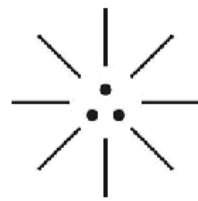

RAIN
(White Blood)

EARTH DAM

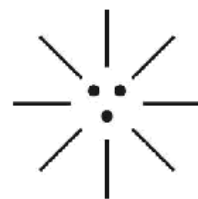

OCEAN
(Fertilized Liquid)

d) How long earth resources will come?...

It is hypothesized that the formation of all resources on the earth planet such as coal, coke, lignite, crude oil, various rocks, minerals, natural gases etc shall be considered due to impact of consistent variation in **salinity potential gradient**. It is further hypothesized that the **earth resources** continue to be in existence and reformed as long as oceans on the earth planet exists. But the fundamental quality of resource fuels varies due to growth of **species fuels**. The whole oceans considered containing billions of different types of fuel cells exists under varied pressure, density, temperature environment.

e) Etymology of word “Dam”?...

Case study shows that “**Dam**” is considered as a **barrier** that is built across the river in order to stop the water from flowing. The dam is also called as “**Reservoir**”.

Further the meaning word “**dam**” is also considered as “**Mother of mankind**”. It is hypothesized that the word “**Dam**” might be derived from proto Indo Europe (PIE) language “**MA-DAM**”. ‘**MA-DAM**’ shall mean “**Earth planet**” or “**Mother of universe**” (Thai-e).

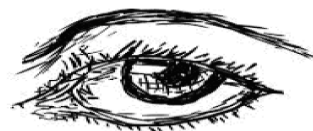
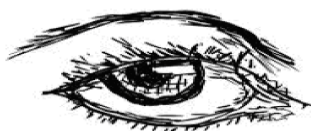

MA-DAM
(MADAM)

f) Case study on Damascus?...

Case study shows that in ancient history “**Damascus**” is referred as city in the river “**Barada**” which rises in the snows of the Anti-Lebanon range and gives the city an **abundant water supply**. It is hypothesized that the word **Damascus** might be derived from the proto Indo Europe origin word “**MA-DAM**” (Super structure).

g) Case study on Mullai Periyar Dam?...

Case study shows that Mullai Periyar Dam was designed and constructed by eminent British engineer **John Pennycuick** (15th January, 1841 - 9th March, 1911). The dam was constructed judiciously for effective water management to divert westward flowing in the Arabian sea towards eastward for useful irrigation purpose to help the dry land area depending on only Vaigai river. The dam constructed across the Periyar river enhanced to the tune of 2.23 lakh acres irrigation in Theni, Dindigul, Madurai, Sivaganga, Ramnad district from the initial irrigation area of 1.69 Lakhs Acre.

Case study shows that though there was acute shortage of fund during British colonial rule, John Pennycuick Sold all his **pennies** of own property in England and could manage and completed the dam construction in 1895 for the benefit of **INDIAN FARMERS** especially for the southern part of Tamilnadu. Case study shows that he does not have any account with “**SWISS BANK**”. It is emphasized that **John Pennycuick** shall be called as “**PONMANACHEMMAL**” of **Maruthai**. Ponmanachemmal shall also mean **Marshal of Marshland** (Marutham).

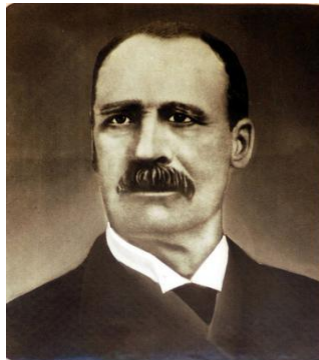

(PONMANACHEMMAL)

“I am going to be only once in the earthly world hence I need to do some good deeds here”

- John Pennycuick

h) Case study on Krishna Raja Sagara Dam?...

Case study shows that the popularly known as KRS dam was constructed across **Kaveri river** near Mysore in Karnataka State. It was constructed in 1924 by eminent engineer M. Visvesvaraya with **vision** for irrigation benefit of **southeast part of India**. Case study shows that Kerala, Andrapradesh, Karnataka states were formed only during 1st November, 1956 under states reorganization act. Shri. Visvesvaraya shall also be called as “**SON OF KAVERI THAI-e**”.

i) Case study on Kallanai Dam?...

Case study shows that Kallanai dam was constructed before 2000 years by Chola King and subsequently remodeled by British rule during 19th Century by captain Caldwell a military engineer. The dam is also called as Grand Anicut and irrigated land area of initially about 69,000 acres and by 20th century nearly about 1 million acres. The dam is still very strong.

III. CONCLUSION

It is focused that the philosophy of “**Dam**” shall be considered as the “**Barrier**” between “**Rain**” and “**Ocean**” for sustainability of “**life**”.

It is further focused that the “**natural resource**” of water shall be well managed by effective “**Leadership Qualities**” with enriched “**common sense**” preferably with “**Radiation status**” by the leaders who dedicated themselves to the “**Nations**”.

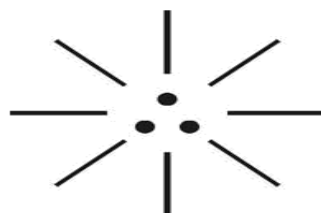

(LAW OF RULE)

- i) **Right dot** - Leadership Qualities (**Common sense**)
- ii) **Left dot** - Managerial qualities (**Intelligence**)
- iii) **Centre dot** - Intuitional qualities (**Wisdom**)

“Rain” shall be considered as “White Blood” and “Ocean” shall considered as composed of various minerals, vitamins, proteins. In the early Universe the ocean shall be considered as highly acidic with low PH value (Dark blue ozone liquid). During the course of expanding Universe the acidity gradually became variant in three geological period and ocean water considered become alkalic with higher PH value. The word “OZONE” might be dialectically pronounced as “OCEAN”.

- Author

IV. PREVIOUS PUBLICATION

The philosophy of origin of first life and human, the philosophy of model Cosmo Universe, the philosophy of fundamental neutrino particles have already been published in various international journals mentioned below. Hence this article shall be considered as **extended version** of the previous articles already published by the same author.

- [1] Cosmo Super Star – IJSRP, April issue, 2013
- [2] Super Scientist of Climate control – IJSER, May issue, 2013
- [3] AKKIE MARS CODE – IJSER, June issue, 2013
- [4] KARITHIRI (Dark flame) The Centromere of Cosmo Universe – IJIRD, May issue, 2013
- [5] MA-AYYAN of MARS – IJIRD, June issue, 2013
- [6] MARS TRIBE – IJSER, June issue, 2013
- [7] MARS MATHEMATICS – IJERD, June issue, 2013
- [8] MARS (EZHEM) The mother of All Planets – IJSER, June issue, 2013
- [9] The Mystery of Crop Circle – IJOART, May issue, 2013
- [10] Origin of First Language – IJIRD, June issue, 2013
- [11] MARS TRISOMY HUMAN – IJOART, June issue, 2013
- [12] MARS ANGEL – IJSTR, June issue, 2013
- [13] Three principles of Akkie Management (AJIBM, August issue, 2013)
- [14] Prehistoric Triphthong Alphabet (IJIRD, July issue, 2013)
- [15] Prehistoric Akkie Music (IJST, July issue, 2013)
- [16] Barack Obama is Tamil Based Indian? (IJSER, August issue, 2013)
- [17] Philosophy of MARS Radiation (IJSER, August 2013)
- [18] Etymology of word “J” (IJSER, September 2013)
- [19] NOAH is Dravidian? (IJOART, August 2013)
- [20] Philosophy of Dark Cell (Soul)? (IJSER, September 2013)
- [21] Darwin Sir is Wrong?! (IJSER, October issue, 2013)
- [22] Prehistoric Pyramids are RF Antenna?!... (IJSER, October issue, 2013)
- [23] HUMAN IS A ROAM FREE CELL PHONE?!... (IJIRD, September issue, 2013)
- [24] NEUTRINOS EXIST IN EARTH ATMOSPHERE?!... (IJERD, October issue, 2013)
- [25] EARLY UNIVERSE WAS HIGHLY FROZEN?!... (IJOART, October issue, 2013)
- [26] UNIVERSE IS LIKE SPACE SHIP?!... (AJER, October issue, 2013)
- [27] ANCIENT EGYPT IS DRAVIDA NAD?!... (IJSER, November issue, 2013)
- [28] ROSETTA STONE IS PREHISTORIC “THAMEE STONE” ?!... (IJSER, November issue, 2013)
- [29] The Supernatural “CNO” HUMAN?... (IJOART, December issue, 2013)
- [30] 3G HUMAN ANCESTOR?... (AJER, December issue, 2013)
- [31] 3G Evolution?... (IJIRD, December issue, 2013)
- [32] God Created Human?... (IJERD, December issue, 2013)
- [33] Prehistoric “J” – Element?... (IJSER, January issue, 2014)
- [34] 3G Mobile phone Induces Cancer?... (IJERD, December issue, 2013)
- [35] “J” Shall Mean “JOULE”?... (IRJES, December issue, 2013)
- [36] “J”- HOUSE IS A HEAVEN?... (IJIRD, January issue, 2014)
- [37] The Supersonic JET FLIGHT-2014?... (IJSER, January issue, 2014)
- [38] “J”-RADIATION IS MOTHER OF HYDROGEN?... (AJER, January issue, 2014)
- [39] PEACE BEGINS WITH “J”?... (IJERD, January issue, 2014)
- [40] THE VIRGIN LIGHT?... (IJCRAR, January issue 2014)
- [41] THE VEILED MOTHER?... (IJERD, January issue 2014)
- [42] GOD HAS NO LUNGS?... (IJERD, February issue 2014)
- [43] Matters are made of Light or Atom?!... (IJERD, February issue 2014)

- [44] THE NUCLEAR “MUKKULAM”?... (IJSER, February issue 2014)
- [45] WHITE REVOLUTION 2014-15?... (IJERD, February issue 2014)
- [46] STAR TWINKLES!?... (IJERD, March issue 2014)
- [47] “E-LANKA” THE TAMIL CONTINENT?... (IJERD, March issue 2014)
- [48] HELLO NAMESTE?... (IJSER, March issue 2014)
- [49] MOTHERHOOD MEANS DELIVERING CHILD?... (AJER, March issue 2014)
- [50] E-ACHI, IAS?... (AJER, March issue 2014)
- [51] THE ALTERNATIVE MEDICINE?... (AJER, April issue 2014)
- [52] GANJA IS ILLEGAL PLANT?... (IJERD, April issue 2014)
- [53] THE ENDOS?... (IJERD, April issue 2014)
- [54] THE “TRI-TRONIC” UNIVERSE?... (AJER, May issue 2014)
- [55] Varied Plasma Level have impact on “GENETIC VALUE”?... (AJER, May issue 2014)
- [56] JALLIKATTU IS DRAVIDIAN VETERAN SPORT?... (AJER, May issue 2014)
- [57] Human Equivalent of Cosmo?... (IJSER, May issue 2014)
- [58] THAI-e ETHIA!... (AJER, May issue 2014)
- [59] THE PHILOSOPHY OF “DALIT”?... (AJER, June issue 2014)
- [60] THE IMPACT OF HIGHER QUALIFICATION?... (AJER, June issue 2014)
- [61] THE CRYSTAL UNIVERSE?... (AJER July 2014 issue)

REFERENCE

- [1] Intensive Internet “e-book” study through, Google search and wikipedia
- [2] M.Arulmani, “3G Akkanna Man”, Annai Publications, Cholapuram, 2011
- [3] M. Arulmani; V.R. Hemalatha, “Tamil the Law of Universe”, Annai Publications, Cholapuram, 2012
- [4] Harold Koontz, Heinz Weihriah, “Essentials of management”, Tata McGraw-Hill publications, 2005
- [5] M. Arulmani; V.R. Hemalatha, “First Music and First Music Alphabet”, Annai Publications, Cholapuram, 2012
- [6] King James Version, “Holy Bible”
- [7] S.A. Perumal, “Human Evolution History”
- [8] “English Dictionary”, Oxford Publications
- [9] Sho. Devaneyapavanar, “Tamil first mother language”, Chennai, 2009
- [10] Tamilannal, “Tholkoppiar”, Chennai, 2007
- [11] “Tamil to English Dictionary”, Suravin Publication, 2009
- [12] “Text Material for E5 to E6 upgradaton”, BSNL Publication, 2012
- [13] A. Nakkiran, “Dravidian mother”, Chennai, 2007
- [14] Dr. M. Karunanidhi, “Thirukkural Translation”, 2010
- [15] “Manorama Tell me why periodicals”, M.M. Publication Ltd., Kottayam, 2009
- [16] V.R. Hemalatha, “A Global level peace tourism to Veilankanni”, Annai Publications, Cholapuram, 2007
- [17] Prof. Ganapathi Pillai, “Sri Lankan Tamil History”, 2004
- [18] Dr. K.K. Pillai, “South Indian History”, 2006
- [19] M. Varadharajan, “Language History”, Chennai, 2009
- [20] Fr. Y.S. Yagoo, “Western Sun”, 2008
- [21] Gopal Chettiar, “Adi Dravidian Origin History”, 2004
- [22] M. Arulmani; V.R. Hemalatha, “Ezhem Nadu My Dream” - (2 Parts), Annai Publications, Cholapuram, 2010
- [23] M. Arulmani; V.R. Hemalatha, “The Super Scientist of Climate Control”, Annai Publications, Cholapuram, 2013, pp 1-3